

tre.o
KITCHENS

B22

B22

Il nuovo progetto B22 coniuga in sé le emozioni dei materiali con l'affidabilità della tecnologia, dove tutto dialoga in modo armonico e coordinato. Una riuscita combinazione per una qualità dell'abitare dove tutto nella cucina acquista valore.

The new project B22 combines the emotions of the materials with the reliability of technology and everything can interact in a harmonious and coordinated way. A successfully combination for a living-quality, where everything in the kitchen becomes more valuable..

Le nouveau projet B22 combine ensemble les émotions des matériaux avec la fiabilité de la technologie, où tout interagit en manière harmonieuse et coordonnée. Une combinaison réussie pour une qualité du vivre, où tout dans la cuisine devient plus précieux

El nuevo proyecto B22 combina las emociones de los materiales con la fiabilidad de la tecnología y todo es integrado de manera armónica y coordinada. Una combinación exitosa para una calidad de el vivir, donde todo en la cocina tiene más valor...

B22

kitchen **1**  pag **04**

kitchen **2**  pag **20**

kitchen **3**  pag **36**

kitchen **4**  pag **52**

kitchen **5**  pag **70**

kitchen **6**  pag **84**

kitchen **7**  pag **100**

INDEX

B22

Cemento bianco
Eucalipto noce scuro
Unicolor ultrabianco
Unicolor cemento

kitchen 1 

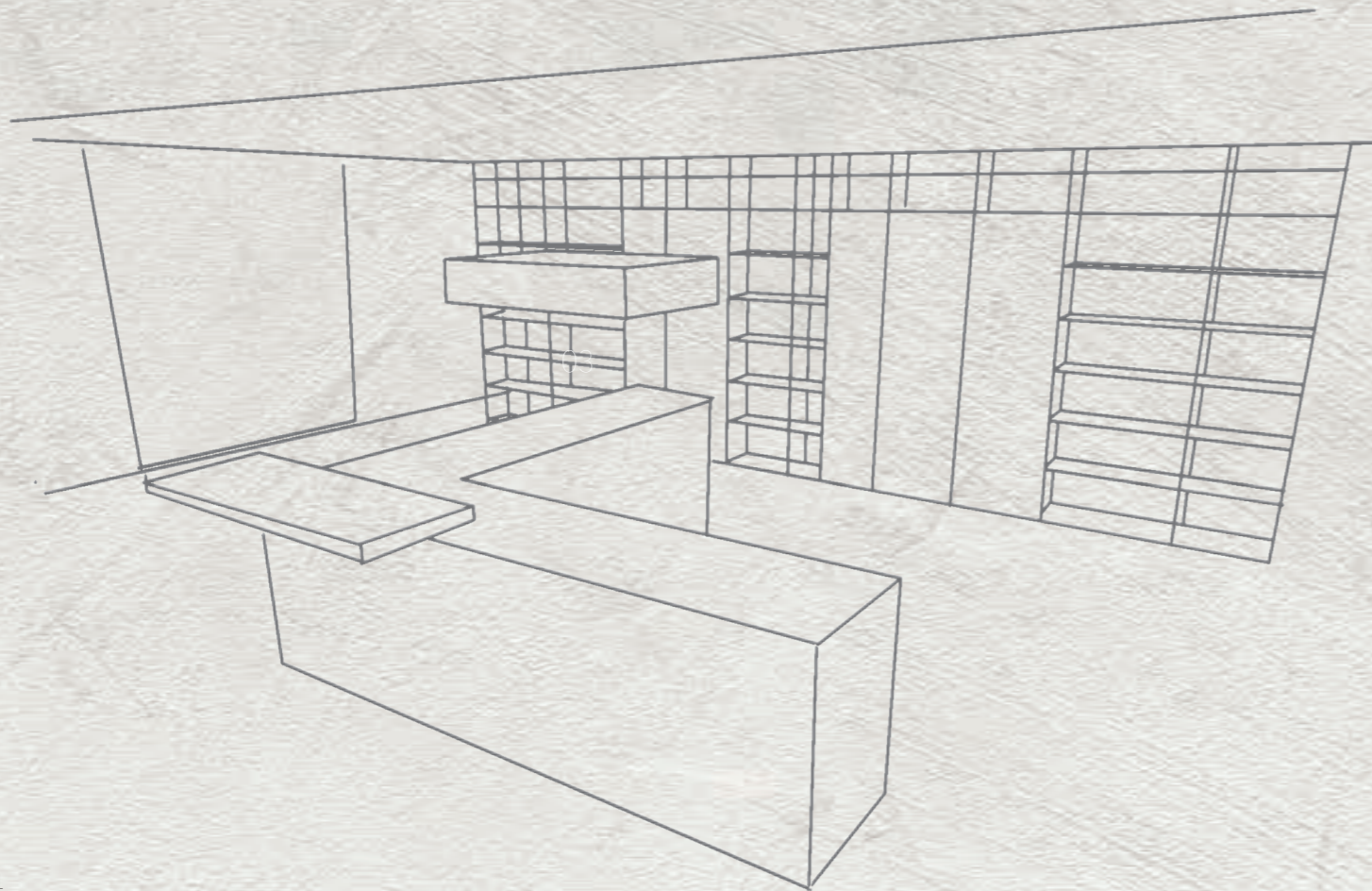

B22

Un grande spazio da vivere con la cucina B22. Importante blocco isola in nobilitato cemento bianco e piano snack in laminato unicolor grigio, libreria in alluminio con profili 25x25, colonne in nobilitato eucalipto noce scuro. Superfici dall'alto valore estetico e funzionale per creare soluzioni uniche.

A large space where to live with a kitchen B22. A huge island of melamine white cement and laminate gray unicolor countertop, aluminum library element with 25x25 cm profiles, tall units of melamine eucalyptus dark walnut. High aesthetic value and functional surfaces to create unique solutions.

Un grand espace à vivre avec la cuisine B22. Importante îlot en mélamine béton blanc et plan de travail en stratifié unicolor gris, bibliothèque en aluminium avec des profils 25x25, armoires en mélamine eucalyptus noyer foncé. Surfaces de grande valeur esthétique et fonctionnelle pour créer des solutions uniques.

Un gran espacio para vivir con la cocina B22. Importante isla en melamina cemento blanco y encimera en laminado unicolor gris, mueble biblioteca con perfiles de aluminio 25x25, columnas en eucalipto nogal oscuro. Superficies de alto valor estético y funcional para crear soluciones únicas.

kitchen 1 







kitchen 1

La cucina è la parte più "in vista" della casa, quella, dove in genere si trascorre molto tempo insieme a famiglia e amici. Deve essere confortevole e accogliente, ma allo stesso tempo pratica e funzionale. B22 coniuga ambienti aperti con la necessità del contenere.

The kitchen is the most visible space of the house, the one where you normally spend a lot of time with family and friends. It must be comfortable and welcoming, but at the same time practical and functional. B22 combines open environments with the need to contain.

La cuisine est la partie plus visible de la maison, celle où généralement vous passez beaucoup de temps avec la famille et les amis. Elle doit être confortable et accueillant, mais en même temps pratique et fonctionnel. B22 associe des espaces ouverts avec la nécessité de contenir.

La cocina es la parte la más visible de la casa, donde normalmente pasamos mucho tiempo con la familia y los amigos. Tiene que ser cómoda y acogedora, pero al mismo tiempo práctica y funcional. B22 combina espacios abiertos con la necesidad de contener.

kitchen 1

Una cucina diversa dalle altre, dove si mescolano perfettamente tecnologia e design, creando un'infinita gamma di soluzioni compositive tale da renderla perfetta e personalizzabile secondo le diverse esigenze.

A kitchen different from the others, where technology and design are perfectly mixed to create an infinite range of compositional solutions that make it perfect and customizable according to your needs.

Une cuisine différente où se mélangent parfaitement technologie et dessin, en créant une gamme infinie de solutions composantes qui la rendent parfaite et personnalisable en fonction de vos besoins.

Una cocina diferente de las otras, donde se combinan perfectamente la tecnología y el diseño, para crear una gama infinita de soluciones compositivas, que la hacen perfecta y personalizable, según vuestras necesidades.



B22

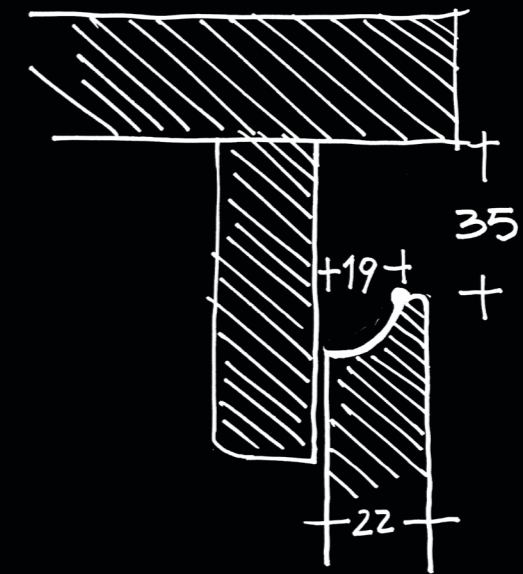

Il nuovo programma B22 coniuga in sé le emozioni dei materiali con l'affidabilità della tecnologia. Una riuscita combinazione per una qualità dell'abitare dove tutto nella cucina acquista valore.

The new program B22 combines the emotions of the materials with the reliability of the technology. A successful combination for a great quality, where everything in our kitchen rises in value.

Le nouveau programme B22 combine les émotions des matériaux à la fiabilité de la technologie. Une combinaison réussie pour une grande qualité de vivre, où tout augmente la valeur de notre cuisine.

El nuevo programa B22 combina las emociones de los materiales con la fiabilidad de la tecnología. Una combinación perfecta de gran calidad, para aumentar el valor de nuestra cocina.

kitchen 1 



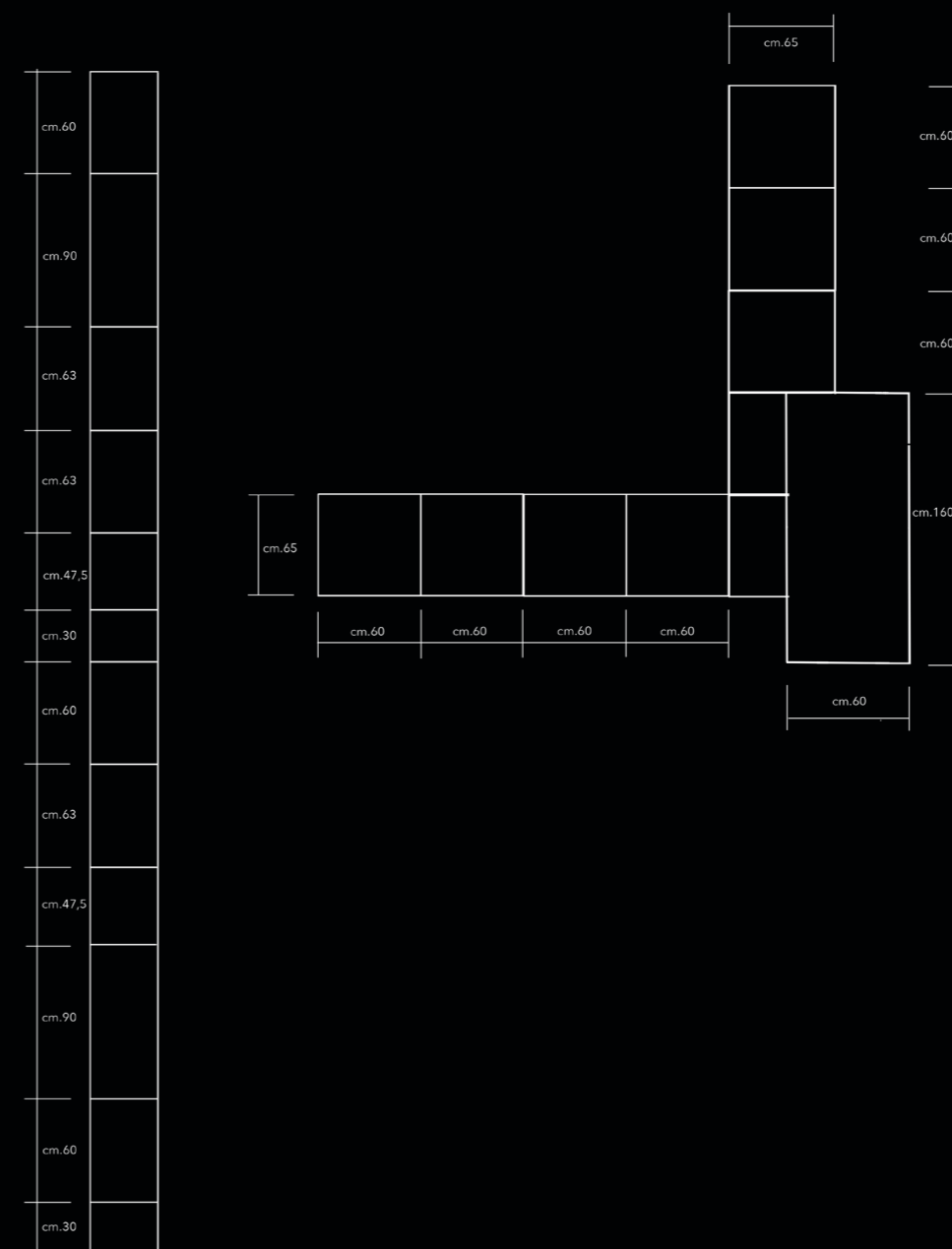

kitchen 1

Geometrie in movimento con attenzione ai dettagli. Design ricercato delle forme compositive e soprattutto la praticità di un'ampia gamma di soluzioni. Una cucina elegante dal sapore contemporaneo, per dare nuove emozioni ai gesti quotidiani.

Moving geometries, paying attention to details. Sophisticated design of the compositional forms and the practicality of a wide range of solutions. An elegant kitchen with a contemporary taste, to give new emotions to daily life..

Géométrie en mouvement, en faisant attention aux détails. La conception sophistiquée des formes de composition et surtout l'utilité d'une large gamme de solutions. Une cuisine élégante avec un goût contemporain, pour donner de nouvelles émotions à la vie quotidienne.

Geometría en movimiento, poniendo atención a los detalles, el diseño sofisticado de las formas y la funcionalidad de una amplia gama de soluciones. Una cocina con estilo, con un sabor contemporáneo, para dar nuevas emociones a la vida diaria..

B22

Laminato fenix bianco kos
Laminato statuario bianco 6019

kitchen 2 

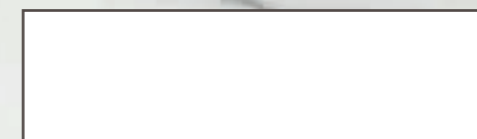
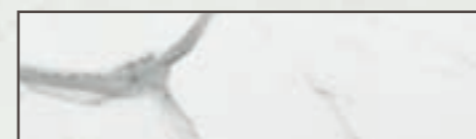
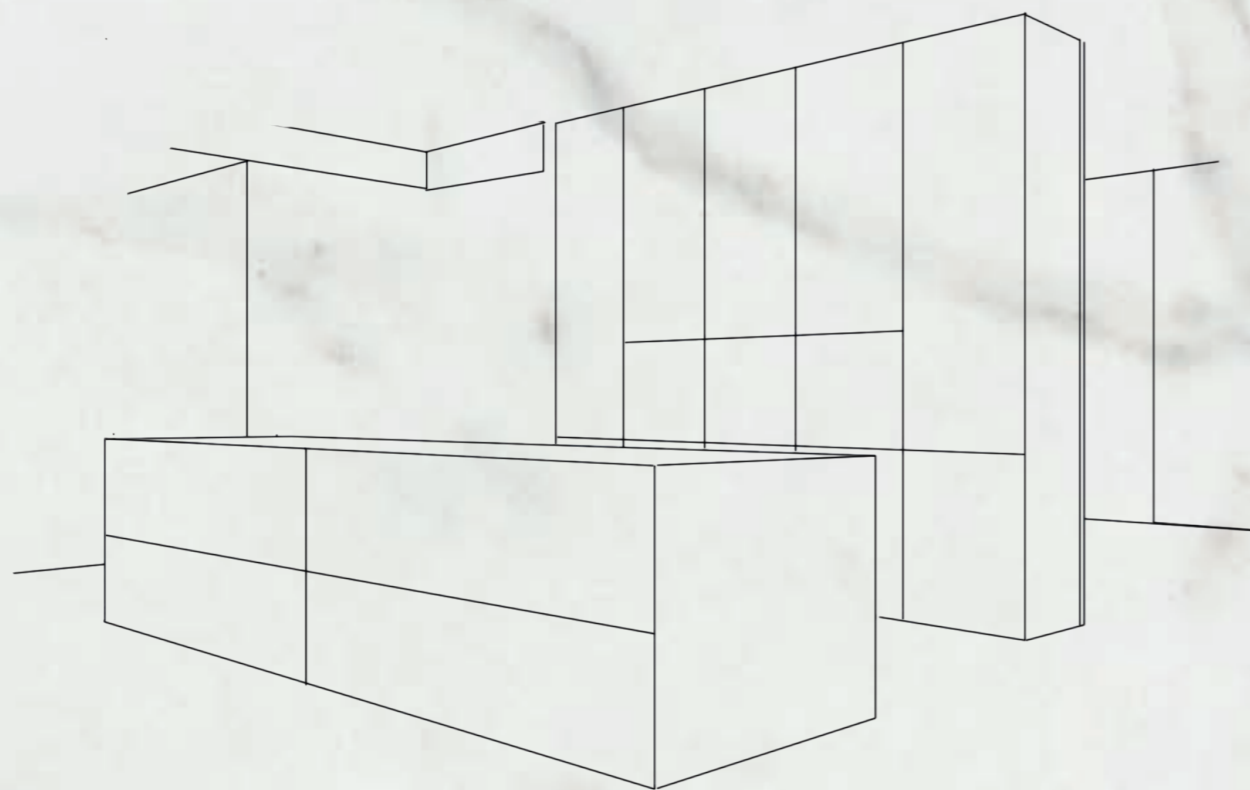



B22

Il linguaggio della tradizione si veste di nuovo, dettagli ricercati di grande personalità, sapori classici per coniugare eleganza, tradizione e modernità, solo così si può essere apprezzati nel tempo e durare a lungo.

The language of tradition is renovated and elaborate details with a strong personality and classic tastes combine elegance, tradition and modernity. The way to be appreciated over time and last for years.

La langue de la tradition change vêtements, nouveaux détails raffinés de grande personnalité, saveurs classiques à combiner élégance, tradition et modernité, juste pour qu'ils puissent être appréciés et durer longtemps.

El lenguaje de la tradición consigue un nuevo aspecto, detalles refinados de grande personalidad, sabores clásicos para coniugar elegancia, tradición y modernidad, solo así se puede ser apreciados en el tiempo y durar a largo plazo.

kitchen 2 





kitchen 2 

Modularità, ergonomia ed elevate performance vivono in simbiosi. Tutto può essere combinato con differenti modelli di maniglie e top, per garantire molteplici combinazioni funzionali e di stile.

Modularity, ergonomics and high performance live in symbiosis. Everything can be combined with different handles and countertops, to ensure several functional and stylish combinations.

Modularité et ergonomie à haute performance vivent en symbiose. Tout peut être combiné avec différents modèles de poignées et plans de travail, pour assurer plusieurs combinaisons fonctionnelles et de style.

Modularidad, ergonomía y alto rendimiento viven en simbiosis. Todo puede ser combinado con diferentes modelos de tiradores y encimeras, para asegurar múltiples combinaciones





kitchen 2 



B22

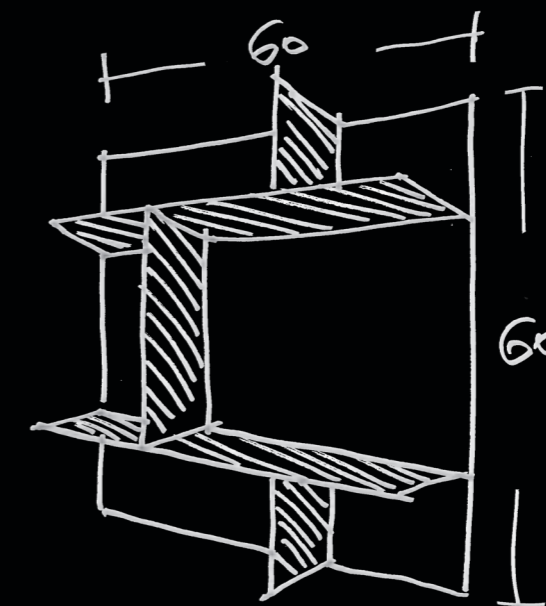
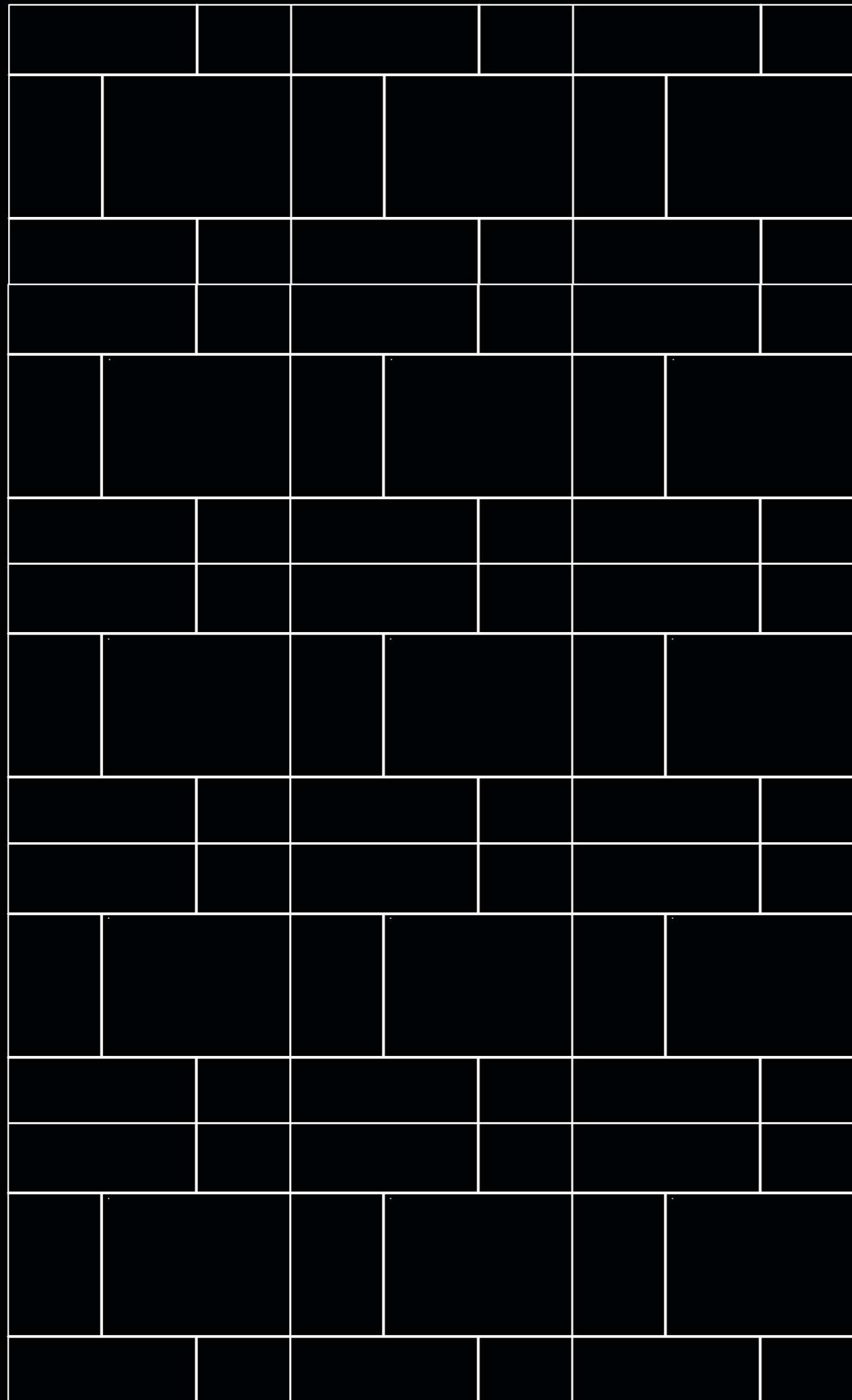

B22 rende più vissuto il nostro mondo contemporaneo, legarsi ad un passato, convivendo con architetture industriali. Uno stile che mette insieme tante anime, passioni, a rappresentare la nuova frontiera della personalizzazione della cucina.

B22 makes much more lived our contemporary world. It creates a direct link with the past continue to cohabit together with industrial architectures. A new style that puts together many souls and passions, to represent the new frontier of customization of the kitchen.

B22 rende plus vécu notre monde contemporain. Il nous permet d'avoir une liaison direct avec le passé, vivant ensemble à les architectures industrielles. Un style qui rassemble beaucoup d'âmes et passions, pour représenter la nouvelle frontière de la personnalisation de la cuisine.

B22 hace que nuestro mundo contemporáneo sea más vivido y que se unen a un pasado y con arquitecturas industriales. Un estilo que combina muchas almas y pasiones, para representar la nueva frontera de la personalización de la cocina.

kitchen 2

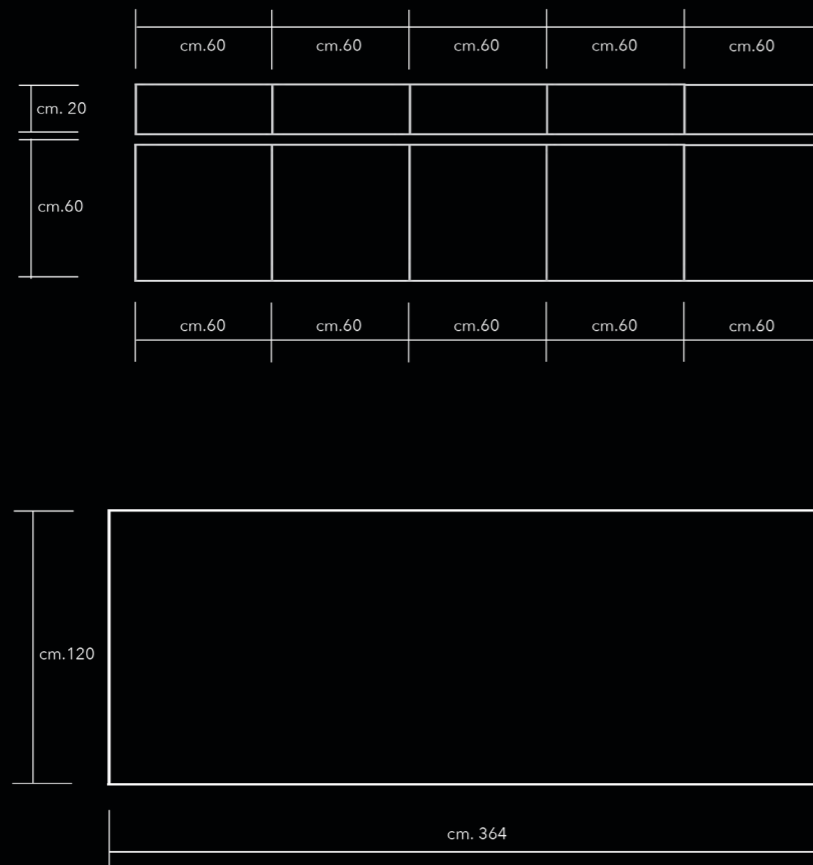

kitchen 2

Nuove mensole in lamiera saldata e schienale in nobilitato personalizzato con il frontale, creano un'area cucina/living dal design sospeso e da un alto livello estetico. Misure diverse per progettare lo spazio del vivere quotidiano, non tralasciando nessun dettaglio.

New shelves with door finished back panel and innovative welded metal opening elements to create a kitchen/living area with a suspended design and a high-level aesthetic. Different sizes to design the space of everyday life, not forgetting any details.

Nouveaux étagères avec dos dans la même finition de la porte et des éléments architecturaux ouverts en métal soudé, pour créer un espace cuisine/séjour de design suspendu avec un niveau esthétique élevé. Dimensions différent pour projeter l'espace de la vie quotidienne sans oublier aucun details.

Nuevos estantes en metal soldado y trasera en melamina color de las puertas, crean una area cocina/salón con un diseño suspendido de alto nivel estético. Diferentes medidas para diseñar el espacio de la vida cotidiana, sin dejar de lado ningún detalle.



B22

Eucalipto noce chiaro
Cemento grigio
Unicolor grigio

kitchen 3 

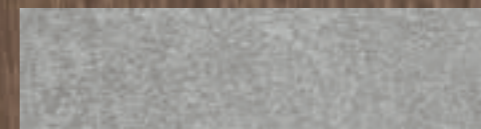
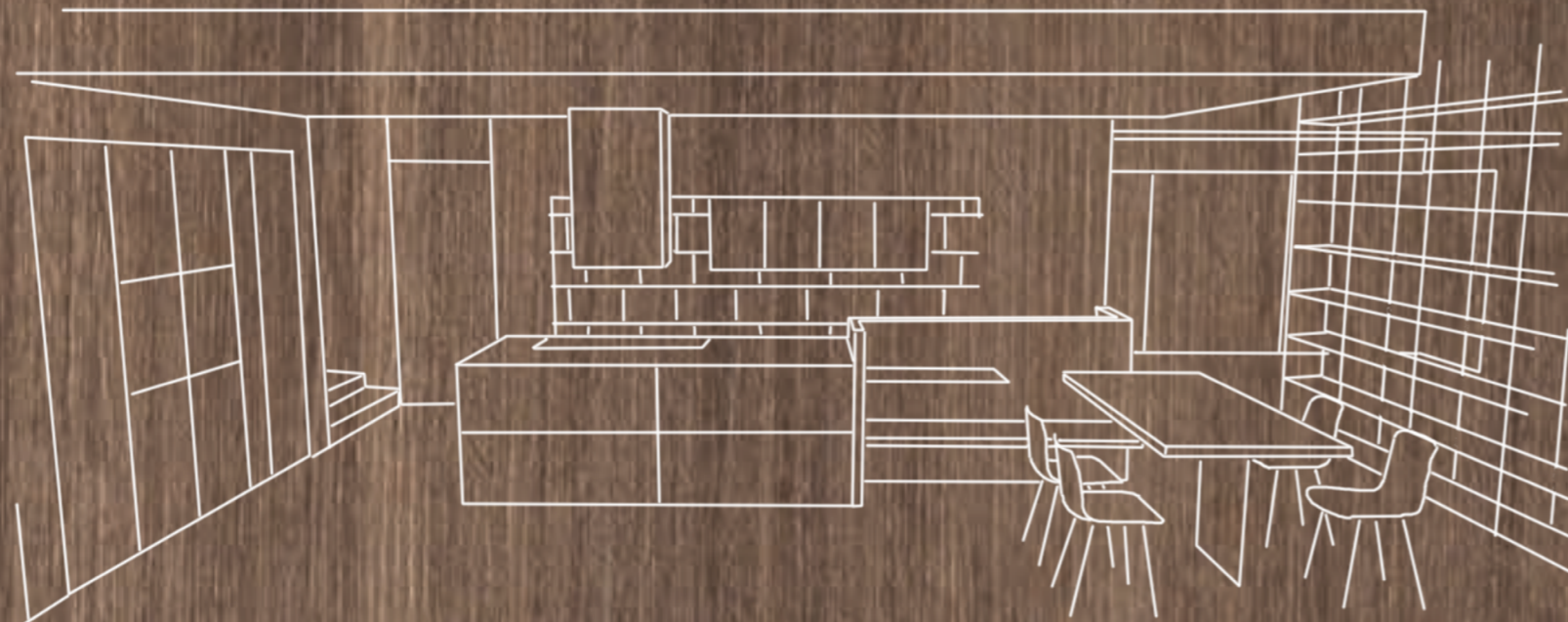



B22

Una scelta dinamica per una composizione lineare con basi isola e zona giorno in nobilitato materico cemento grigio, pensili in nobilitato eucalipto noce chiaro. Superfici morbide al tatto ma allo stesso tempo funzionali e resistenti. Le colonne in nobilitato eucalipto noce chiaro si arricchiscono architettonicamente con elementi a giorno in lamiera saldata dal grande impatto visivo, creando un'atmosfera ricercata e unica.

A dynamic choice for a linear composition with melamine grey cement island and living area, eucalyptus light walnut wall units. Soft-touch surfaces but functional and strong at the same time. Melamine eucalyptus light walnut tall units are architecturally enriched by innovative welded metal opening elements, which create a sophisticated and unique atmosphere.

Un choix dynamique pour une composition linéaire avec des éléments bas îlot et séjour en mélamine ciment gris et éléments hauts en mélamine eucalyptus noyer clair. Surfaces douces au toucher mais au même temps fonctionnelles et résistantes. Les armoires en mélamine eucalyptus noyer clair sont enrichies avec des éléments architecturaux ouverts en métal soudé, de grand impact visuel, en créant une atmosphère sophistiquée et unique.

Una idea dinámica para una composición lineal con muebles bajos en la isla y en el salón en melamina cemento gris, colgantes en melamina acabado eucalipto nogar claro. Superficies suaves al tacto, pero al mismo tiempo funcionales y durables. Columnas en melamina eucalipto nogar claro se enriquecen con elementos arquitectónicos abiertos de metal soldado, de gran impacto visual, creando una atmósfera sofisticada y única.

kitchen 3 



Nuove mensole con pannello di supporto in finitura frontale e innovative lamiera saldate, creano un'area cucina/living dal design sospeso e da un alto livello estetico. Il progetto dello spazio del vivere quotidiano non trascurava nessun dettaglio.

New shelves with door finished support panel and innovative welded metal opening elements to create a kitchen/living area with an exceptional design and a high aesthetic level. The space project of everyday life does not miss any details.

Nouveaux étagères avec panneaux de support en la même finition que les façades et des éléments architecturaux ouverts en métal soudé, pour créer un espace cuisine/séjour avec un dessin exceptionnel et un niveau esthétique élevé. Le projet de l'espace de la vie quotidienne ne omette aucuns détails.

Nuevos elementos estantería con panel de soporte en el mismo acabado de los frontales y nuevas hojas de metal soldadas, para crear una zona de cocina / salón de diseño excepcional y con un alto nivel estético. El proyecto del espacio de la vida cotidiana no omite ningún detalle.

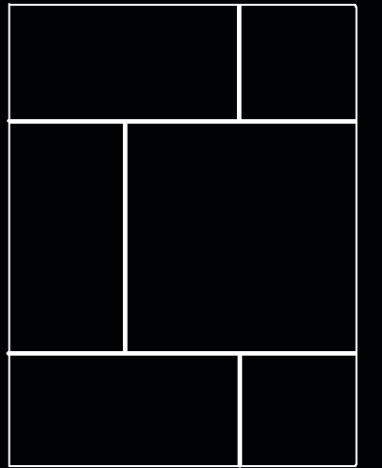

B22

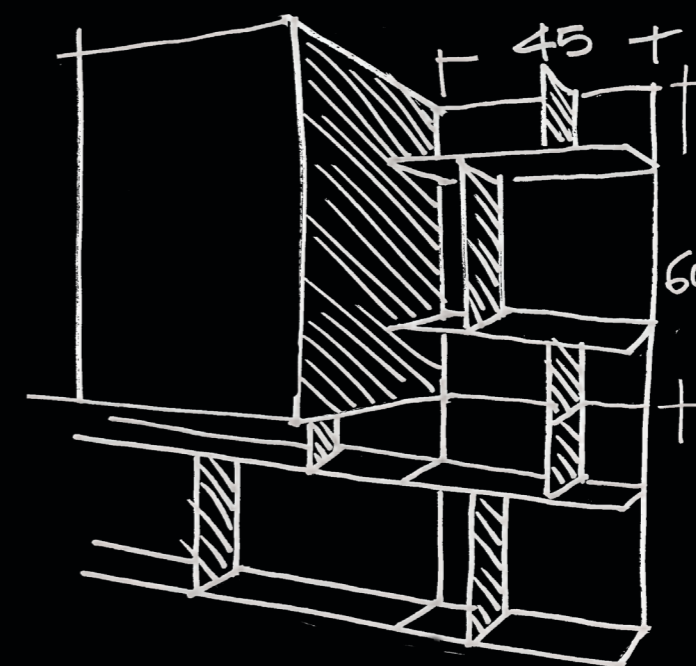

kitchen 3 

Nuovi spazi grafici per un nuovo linguaggio progettuale orientato alla concretezza e alla versatilità. Il living si integra armonicamente con la cucina e crea dettagli di design, definendo un modello dal grande equilibrio compositivo.

New graphic spaces for a new design language oriented to concreteness and versatility. The living area is harmoniously integrated with the kitchen and creates design details, defining a model with a large compositional balance.

Nouveaux espaces graphiques pour un nouveau langage de conception orienté vers le concret et la versatilité. Le living se mélange harmonieusement avec la cuisine et crée des détails de conception pour la définition d'un modèle de grand équilibre au niveau de la composition.

Nuevos espacios gráficos para un nuevo lenguaje de diseño orientado a la concreción y a la versatilidad. La zona living se integrará con armonía con la cocina y crea detalles de diseño para la definición de un modelo de gran equilibrio compositivo.



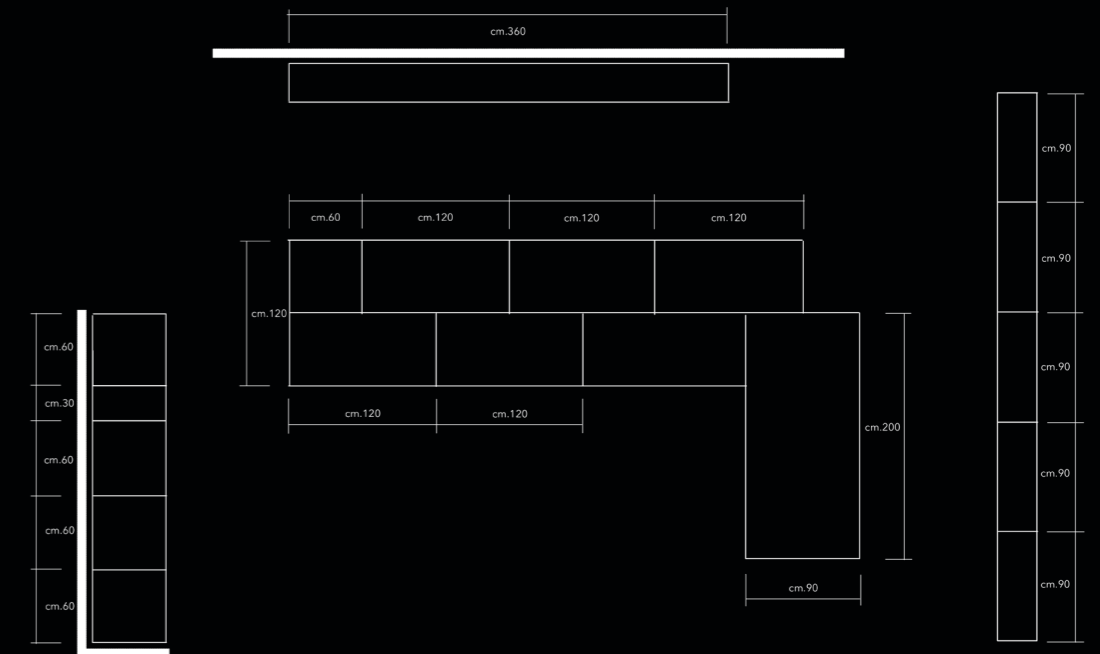

kitchen 3

Cucine progettate per completare qualsiasi ambiente, una ricca gamma di colori, finiture e materiali rendono tutto ciò realizzabile. Con il programma B22, TreO Cucine risponde a questi bisogni sempre più diffusi e importanti per i clienti.

Kitchens designed to complete any environment. A wide range of colours, finishes and materials make everything possible. With B22 model, TreO Cucine satisfy all needs becoming increasingly popular and important for the customers...

Cuisines projetées pour tous les environnements. Une large gamme de couleurs, de finitions et de matériaux rendent tout possible. Avec le modèle B22, TreO Cucine répond à ces besoins de plus en plus populaires et importants pour les clients.

Cocinas diseñadas para complementar cualquier ambiente, una amplia gama de colores, acabados y materiales hacen todo eso realizable. Con el modelo B22, TreO Cucine responde a estas necesidades siempre más popular y importante para los clientes.



B22

Eucalipto grigio
Cemento perlato FB53
Nobilitato grigio cobalto
Dekton kelia

kitchen 4 

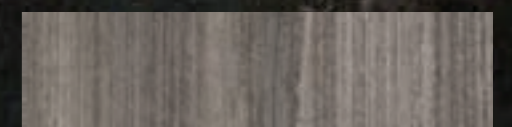
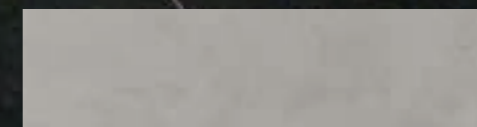
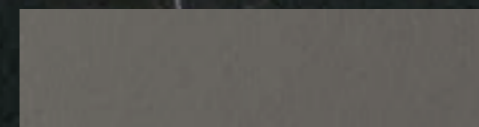
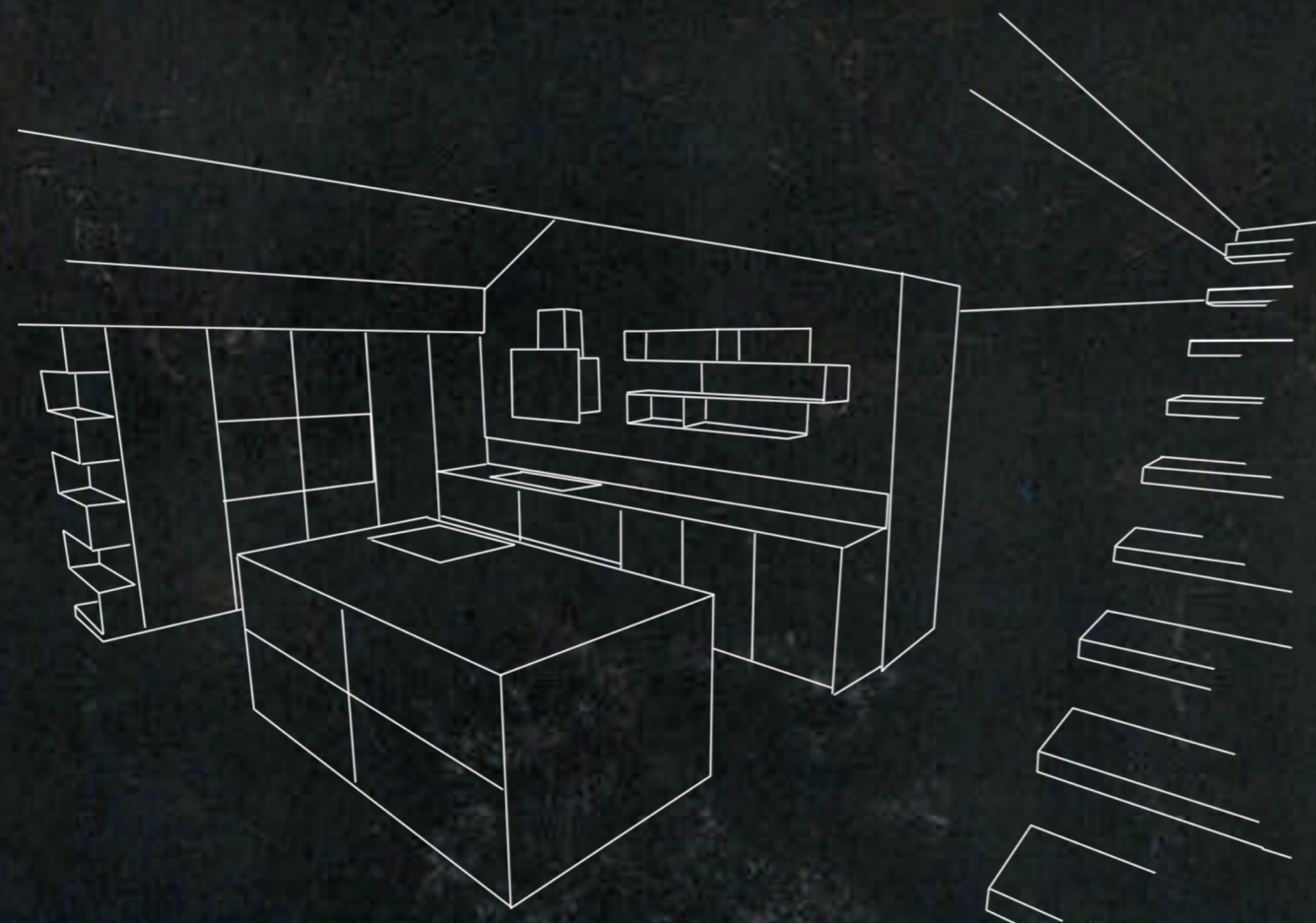



Una scelta dinamica per una composizione che da sola arreda la casa. Basi cucina ed isola in nobilitato cemento perlato, colonne in finitura legno nobilitato eucalipto grigio. Nella zona pensili e colonne vengono inserite delle mensole in nobilitato grigio cobalto dalla forma ricercata.

A dynamic choice for a composition that furnished the home. Melamine pearl cement base units and island, melamine Eucalyptus grey tall units. Melamine cobalto grey shelves with a particular shape are installed on wall and tall units area.

Un choix dynamique pour une composition que tout seule peut aménager la maison. Élément bas et îlot en mélamine ciment perlé, armoires en mélamine Eucalyptus gris. Dans la partie arrière, entre les éléments hauts et les armoires, nous avons ajoutée des étagères en mélamine gris cobalto avec une forme très particulière.

Una elección dinámica para una composición que ya sólo amuebla la casa. Muebles bajos y isla en melamina cemento perlado, columnas en melamina Eucalipto gris. En la parte posterior entre colgantes y columnas nosotros hemos puesto algunos estantes en melamina gris cobalto con forma particular.





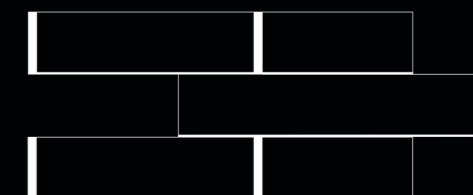

kitchen 4

Questo progetto permette di interpretare l'ambiente cucina con versatilità e carattere. Il gusto e la grazia dei sapori antichi in chiave contemporanea. Sempre alla ricerca di nuove idee d'arredo per creare un linguaggio dove lo spazio si trasforma.

This project gives the opportunity to interpret the kitchen environment with versatility and character. Traditions review in a contemporary way, always looking for new furnishing ideas to create a language where the space is transformed.

Ce projet permet d'interpréter la cuisine avec versatilité et caractère. Le goût et la grâce des saveurs traditionnelles transformés en manière contemporaine, toujours à la recherche de nouvelles idées pour meubler et pour créer un langage où l'espace se transforme.

Este proyecto nos permite de interpretar el ambiente cocina con versatilidad y carácter. El sabor y la gracia de los sabores tradicionales transformados de una manera contemporánea. Siempre buscando nuevas ideas de decoración para crear un lenguaje donde el espacio se transforma.

B22

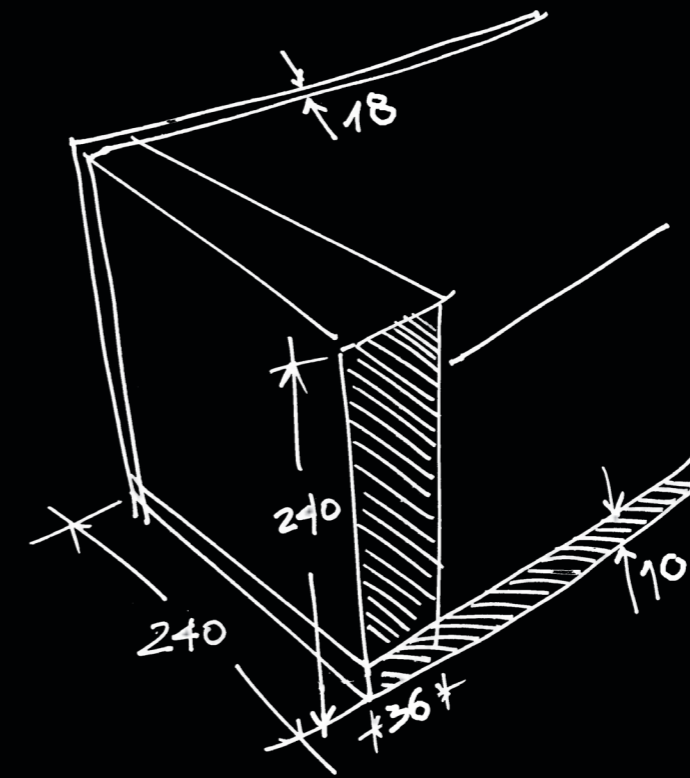
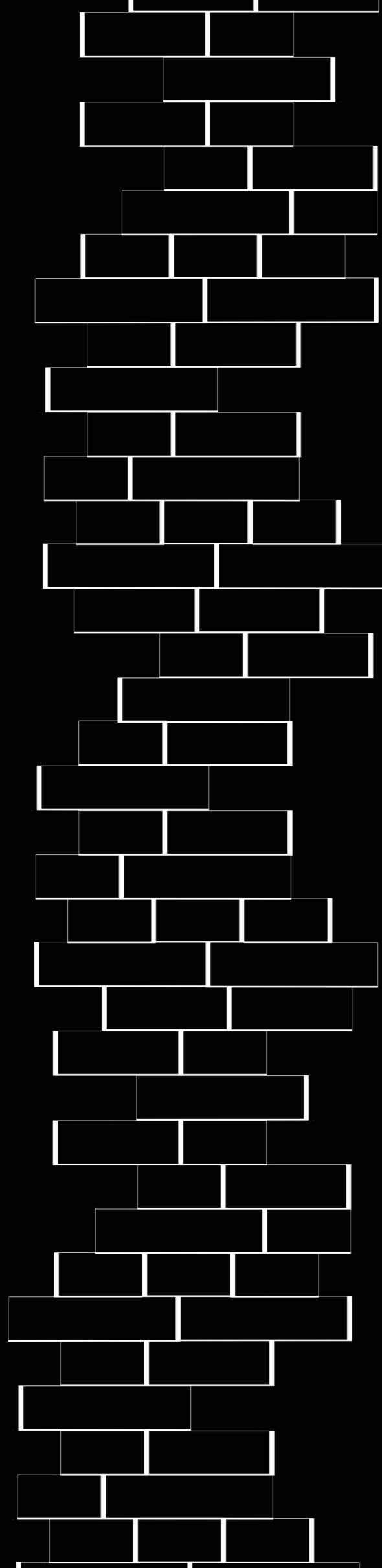

L'intelligenza della semplificazione è uno dei grandi temi della progettazione. Rendere il design al servizio della funzionalità per creare un valore accessibile. Queste composizioni cercano di rispondere a questi requisiti e diventano la missione dichiarata di questo progetto.

The intelligence of simplification is one of the major themes of the design. Use the design to create an affordable value. Those compositions try to answer to these requirements and become the declared mission of this project.

L'intelligence de la simplification est un des grands thèmes du projet. Le dessin est au service de la fonctionnalité pour créer un valeur accessible. Ces compositions essaient de répondre à ces exigences et elles deviennent la mission déclarée de ce projet.

La inteligencia de la simplificación es uno de los grandes temas en el diseño. El design esta al servicio de la funcionalidad para crear un valor añadido. Estas composiciones intentan de responder a estas necesidades y son la mission declarada de este proyecto.

kitchen 4

kitchen 4

Seguire la pulizia della luce, vivere l'armonia di linee e volumi. Progettata per aggiungere emozione all'ambiente più importante della casa, dove la qualità del prodotto, si percepisce dalla cura dei suoi dettagli.

Follow the simplicity of the light, live the harmony of lines and volumes. Designed to add emotion to the most important place of the house, where the product quality is perceived by the attention to details.

Suivre la simplicité de la lumière, vivre l'harmonie de lignes et volumes. Projetée pour ajouter émotion à l'ambiance la plus importante de la maison, où la qualité du produit se montre à travers l'attention aux détails.

Seguir la limpieza de la luz, vivir la armonía de las líneas y de los volúmenes. Diseñada para añadir emociones a la zona más importante de la casa, donde la calidad del producto se ve a través de l'atención a los detalles.



kitchen 4

Un ambiente apparentemente nuovo che porta con sé uno stile che farà tendenza. Un gioco misurato di finiture che rende unica e garbata questa composizione. Sostanziosa nel suo elemento dominante, ma con una perfetta convivenza tra raffinatezza ed alte prestazioni.

Apparently a new environment with a trendy style. Sophisticated for its dominant element, but with a perfect balance between elegance and performance.

Une ambiance apparemment nouvelle qui apporte un style qui fera tendance. Un jeu de finitions qui rend unique et gracieuse cette composition. Sophistiquée dans son élément dominant, mais avec un équilibre parfait entre l'élégance et les autres performances.

Un ambiente que parece nuevo, que trae un estilo de tendencia. Un juego de acabados que hace única y elegante esta composición. Sofisticada en su elemento dominante, pero con una perfecta convivencia entre sofisticación y rendimiento.



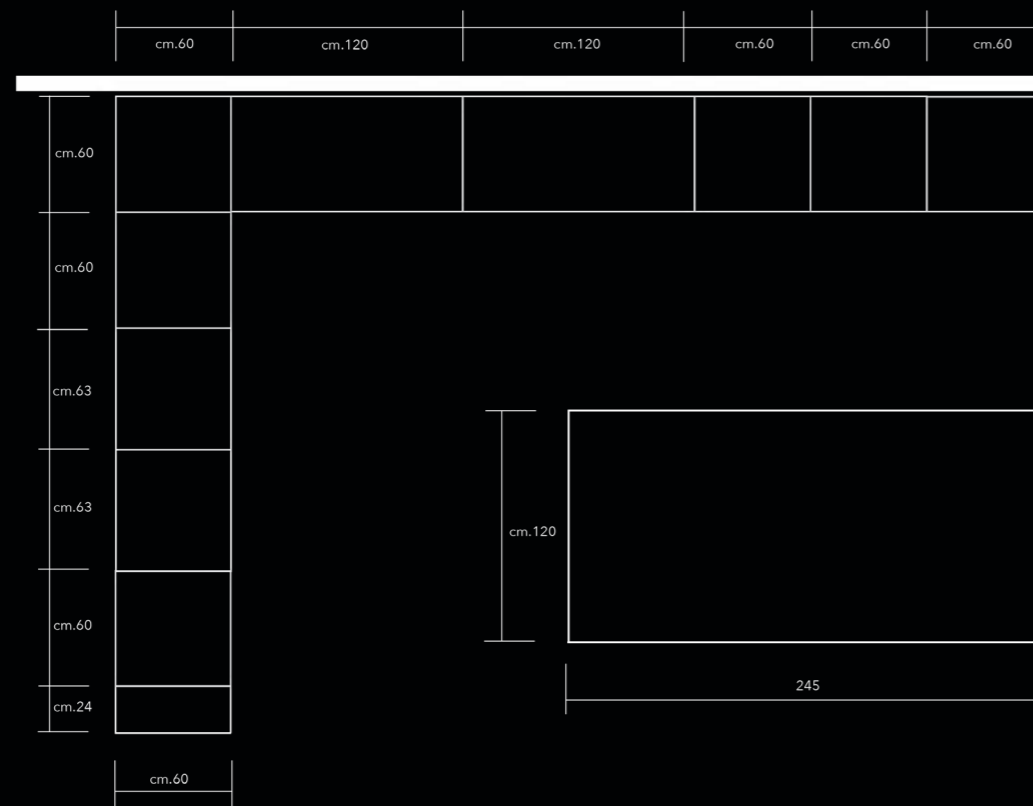

kitchen 4

Un progetto innovativo e ambizioso, ideale per soluzioni in cui la cucina condivide gli spazi con il living. Un risultato eccellente, frutto di ricerche scrupolose, che consentono un inedito connubio tra la "forza scenica" e l'indiscutibile funzionalità.

An innovative and ambitious project, ideally solutions where the kitchen shares space with the living room. An excellent result of meticulous research, that allows a wonderful combination of aesthetic and functionality.

Un projet innovant et ambitieux, idéal pour solutions où la cuisine et le salon se trouvent dans le même espace. Un excellent résultat de recherches minutieuses qui permettent une combinaison inédite entre la « puissance scénique » et la fonctionnalité indiscutable.

Un proyecto innovador y ambicioso, ideal para soluciones donde la cocina y el living estan en el mismo espacio. Un excelente resultado fruto de varias investigaciones que permiten una combinación entre la estética y la funcionalidad.



B22

Nobilitato grigio cobalto
Nobilitato rovere nodato bianco
Unicolor emerald
Dekton ventus

kitchen 5 

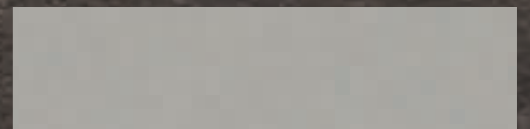
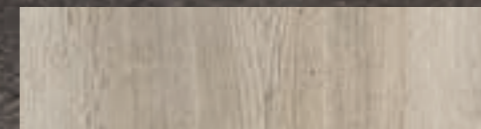
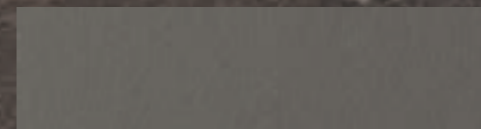
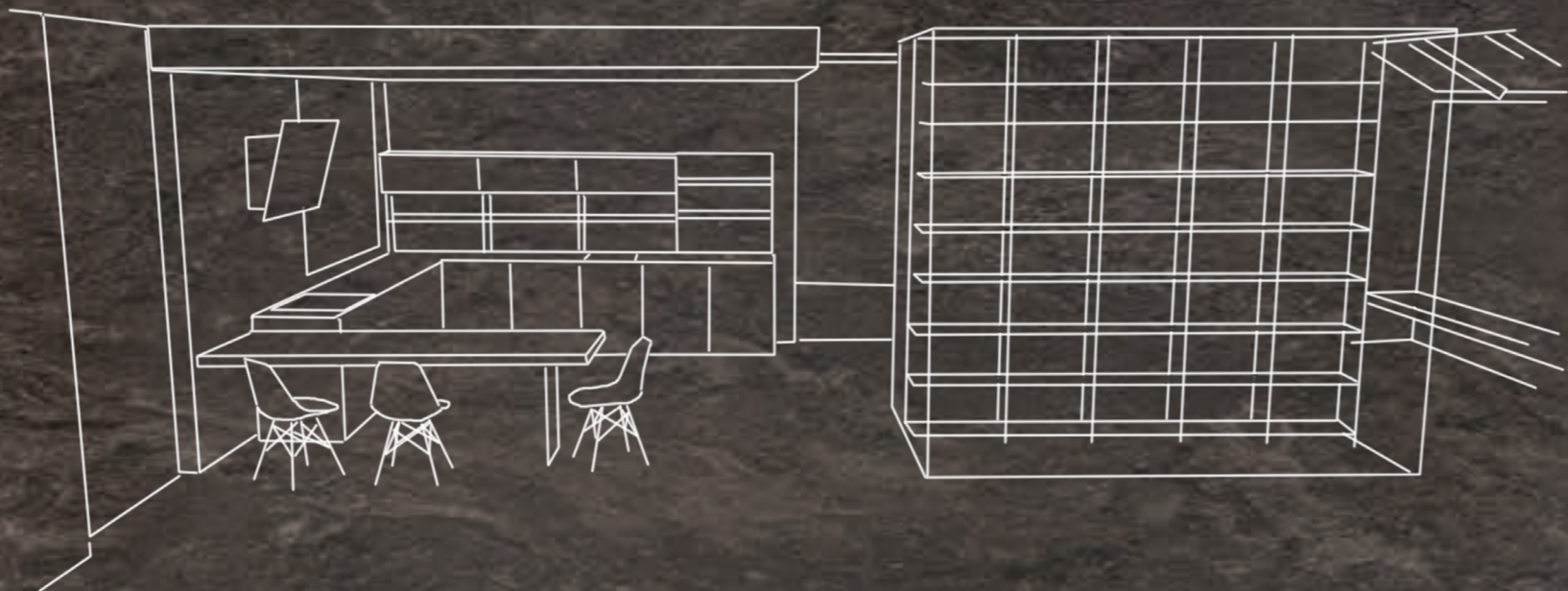



B22

Le colonne e i pensili proposti in questa cucina sono in nobilitato grigio cobalto. Perfettamente armonizzate con le basi in nobilitato rovere nodato bianco e la penisola in laminato unicolor emerald. Le pareti attrezzate che fanno da schienale e da armadio cantina sono in alluminio.

In this composition we propose melamine cobalto grey tall units and wall units, perfectly combined with melamine white oak with nodes base units and a laminated unicolor Emerald countertop. The equipped wall elements that form the back panel and the wine cellar, are in aluminium.

Les armoires et les éléments hauts proposés dans cette composition sont en mélamine gris cobalto, parfaitement harmonisés avec les éléments bas en mélamine chêne blanc avec noeuds et le plan de travail stratifié unicolor Emerald. Les éléments équipés à mur qui forment le dos et le cave à vin sont en aluminium.

Las columnas y los muebles bajos propuestos en esta cocina son en melamine gris cobalto. Son perfectamente adaptados con los muebles bajos en melamine roble blanco con nudos y la encimera laminada unicolor Emerald. Las paredes equipadas que forman la trasera y la vitoteca están hechas de aluminio.

kitchen 5 



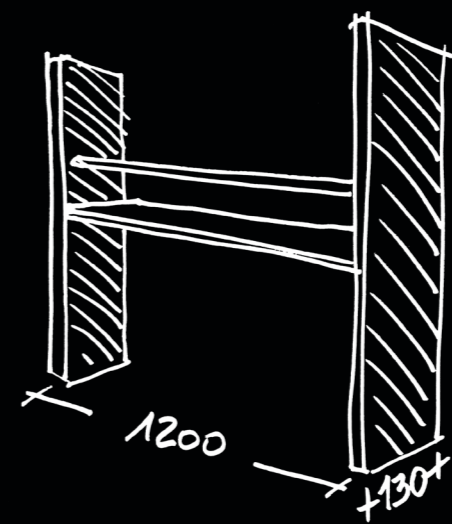

kitchen 5 

Curata in ogni particolare, pensata per essere una cucina al centro della vita in casa, offrendo una ampia scelta di accessori, scelta cromatica e finitura delle ante. Pensata per chi ama la bellezza e il gusto decorativo e vuole personalizzare la propria soluzione ideale

Designed in every single detail and thought to be a kitchen in the middle of your daily life. It offers a wide selection of accessories, finishes and colours. Designed for those who love beauty and decoration and want to customize their ideal solution.

Etudié en tous les détails et pensée pour être une cuisine au centre de la maison, elle offre une large sélection d'accessoires, de coloris et de finitions. Pensée pour ceux qui aiment la beauté et la décoration et ceux qui veulent personnaliser leur solution idéale.

Estudiada en cada detalle y destinada a ser una cocina en el centro de la vida familiar, ofrece una amplia selección de accesorios, colores y acabados de las puertas. Diseñada para los que aman la belleza y el gusto decorativo y quiere personalizar su solución ideal.







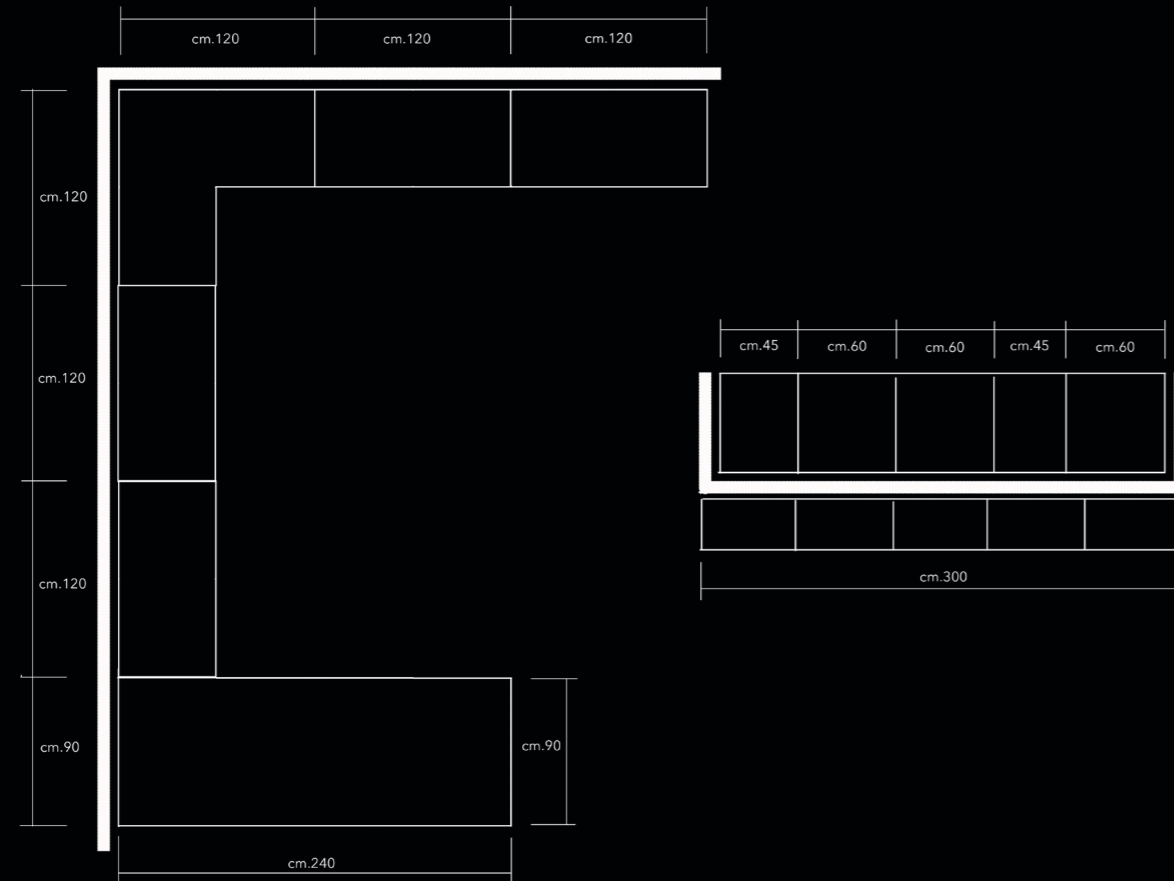

kitchen 5

Bella, ergonomica e ben organizzata, la cucina è pronta a nascondersi dietro ampie ed essenziali superfici con apertura/chiusura scorrevole a scomparsa. Non semplici colonne di contenimento, ma vere e proprie armadiature che sfruttano al meglio lo spazio, rendendo tutto molto più pratico, agevole e ordinato.

Beautiful, ergonomic and well organized, the kitchen can be hidden behind large and essential surfaces with open/close sliding doors system. Not simple containing columns, but real cabinets that exploit all the space, making it much more practical, easy and tidy.

Belle, ergonomique et bien organisée, la cuisine est prête à se cacher derrière des surfaces grandes et essentielles avec ouverture/fermeture coulissante. Pas de simples colonnes de rangement, mais de véritables armoires qui utilisent au maximum l'espace, en rendant tout plus pratique, confortable et bien arrangé.

Hermosa, ergonómica y bien organizada, la cocina está lista para esconderse atrás de superficies grandes y esenciales con apertura/cierre deslizante. No simples columnas de contención, son armarios reales que aprovechan la mayor parte del espacio y lo hacen mucho más práctico, cómodo y ordenado.



B22

Laccato bianco opaco
Acciaio
Nobilitato grigio cobalto

kitchen 6 

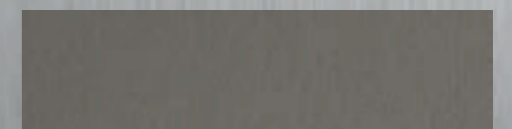
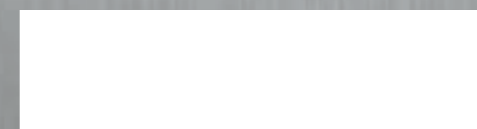
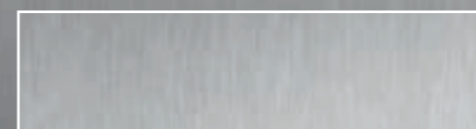
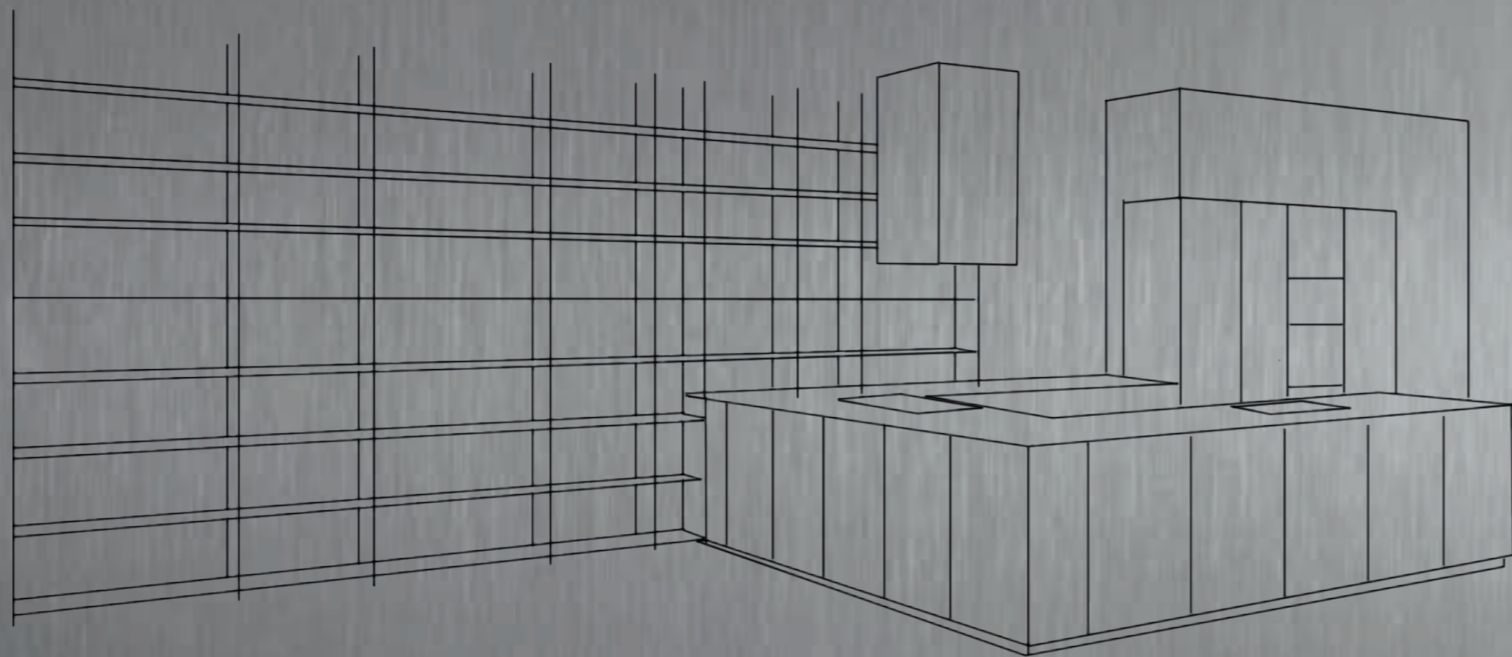

B22

Linearità e razionalità assemblate per una soluzione semplice ma efficiente. Basi e colonne in laccato bianco opaco. Top e schienale in acciaio satinato. L'imponente struttura libreria in alluminio satinato con i ripiani in nobilitato grigio cobalto.

Linearity and rationality assembled for a simple but efficient solution. White matt lacquered base and tall units. Satin steel finished countertop and backsplash. The stately library element in satin aluminum has melamine cobalto grey shelves.

Linéarité et rationalité assemblées pour une solution simple mais efficace. Elements bas laqué blanc mat. Plan de travail et crédence en acier brossé. L'imposant structure bibliothèque en aluminium brossé a des étagères en mélamine gris cobalto.

Linealidad y racionalidad ensambladas por soluciones simples pero eficientes. Muebles bajos lacados blanco mate. Encimera y trasera en acero cepillado. Gran estructura biblioteca en aluminio cepillado con estantes en melamina gris cobalto.

kitchen 6 





L'integrazione tra cucina e living è risolta con eleganza e gusto grazie ad una libreria in alluminio satinato, dove i ripiani possono essere personalizzati al frontale della cucina. Un nuovo ordine funzionale incarna il concetto di design per nuove soluzioni visive.

The kitchen and the living room are perfectly integrated, thanks to an open library element in satin aluminum, where shelves can be personalized as the kitchen doors. A new functional order highlights the concept of design for new visual situations.

L'intégration entre la cuisine et le séjour vient faite avec élégance et goût grâce à l'aide d'une structure bibliothèque en finition aluminium brossé avec les étagères personnalisés dans la couleur de la porte de la cuisine. Un nouveau ordre fonctionnel incarne le concept du design pour de nouvelles solutions visuelles.

La integración entra la cocina y el salón se resuelve con elegancia y buen gusto, gracias a la estructura biblioteca en aluminio cepillado donde los estantes pueden ser personalizados como el frontal de la cocina. Un nuevo orden funcional encarna el concepto de design para nuevas soluciones visuales.

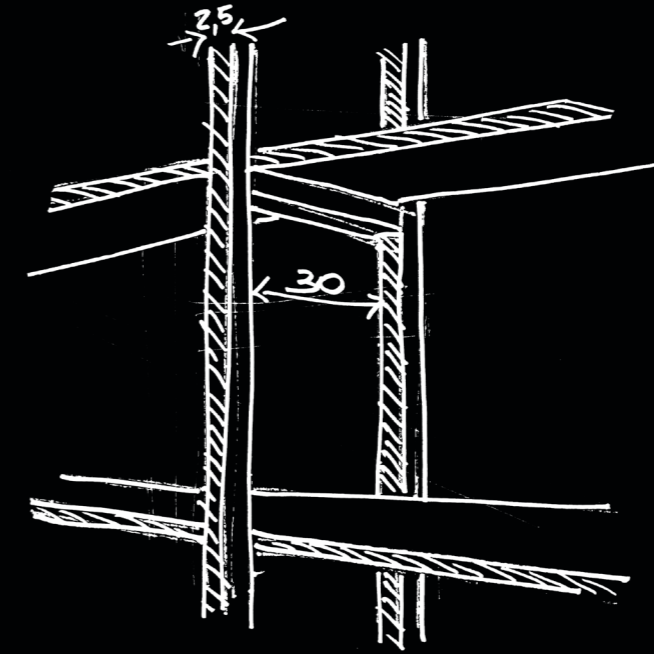

B22

kitchen 6 





kitchen 6

Grazie a soluzioni compositive flessibili e funzionali, B22 interpreta l'unicità del proprio mondo, adattandosi a dimensioni e forme della propria casa. L'elegante profilo gola, in tinta con i frontali crea una cucina minimale ma raffinata.

Thanks to flexible and functional compositions, B22 represents the uniqueness of your world, adapting to the size and shape of your home. Matching elegant handle channel, lacquered as the doors, create a minimal but refined kitchen.

B22 interprète l'unicité de son monde, grâce à des solutions compositives flexibles et fonctionnelles, en se adaptant aux dimensions et aux formes de votre maison. L'élégance de la gorge, dans la même couleur de la façade, crée une cuisine minimale mais raffinée.

Con composiciones flexibles y funcionales, B22 interpreta la singularidad de su mundo, adaptándose a las formas y los tamaños de la casa. El elegante perfil gola, a juego con las puertas, crea una cocina minimalista y refinada.





Le atmosfere calde e familiari sono espresse nella cura dei dettagli che rende funzionale ed armonioso lo stile di B22. Questo programma abbina linee morbide e particolari distintivi, con la massima praticità di utilizzo e dal costo accessibile.

The warm and familiar atmosphere is expressed through the attention to details that makes functional and harmonious B22. This program combines smooth lines and distinctive details, with the maximum practical use and affordable price.

L'atmosphère chaleureuse et familiale vient exprimée par l'attention aux détails qui rend le style de B22 fonctionnel et harmonieux. Ce projet combine des lignes douces et des détails distinctifs, avec la pratique d'utilisation et le prix abordable.

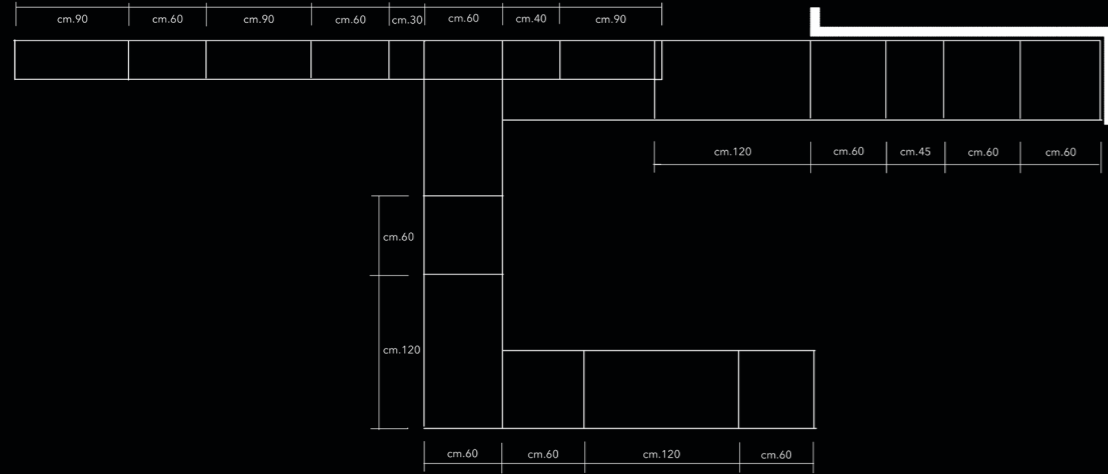
Las atmósferas calientes y familiares se expresan en la atención al detalle que hace funcional y armonioso el estilo de B22. Este programa combina líneas suaves y detalles distintivos, con la máxima funcionalidad de uso y con un costo asequible.



kitchen 6 

Le atmosfere calde e familiari sono espresse nella cura dei dettagli che rende funzionale ed armonioso lo stile di B22. Questo programma abbina linee morbide e particolari distintivi, con la massima praticità di utilizzo e dal costo accessibile.

The warm and familiar atmosphere is expressed through the attention to details that makes functional and harmonious B22. This program combines smooth lines and distinctive details, with the maximum practical use and affordable price.

L'atmosphère chaleureuse et familiale vient exprimée par l'attention aux détails qui rend le style de B22 fonctionnel et harmonieux. Ce projet combine des lignes douces et des détails distinctifs, avec la pratique d'utilisation et le prix abordable.

Las atmósferas calientes y familiares se expresan en la atención al detalle que hace funcional y armonioso el estilo de B22. Este programa combina líneas suaves y detalles distintivos, con la máxima funcionalidad de uso y con un costo asequible.



B22

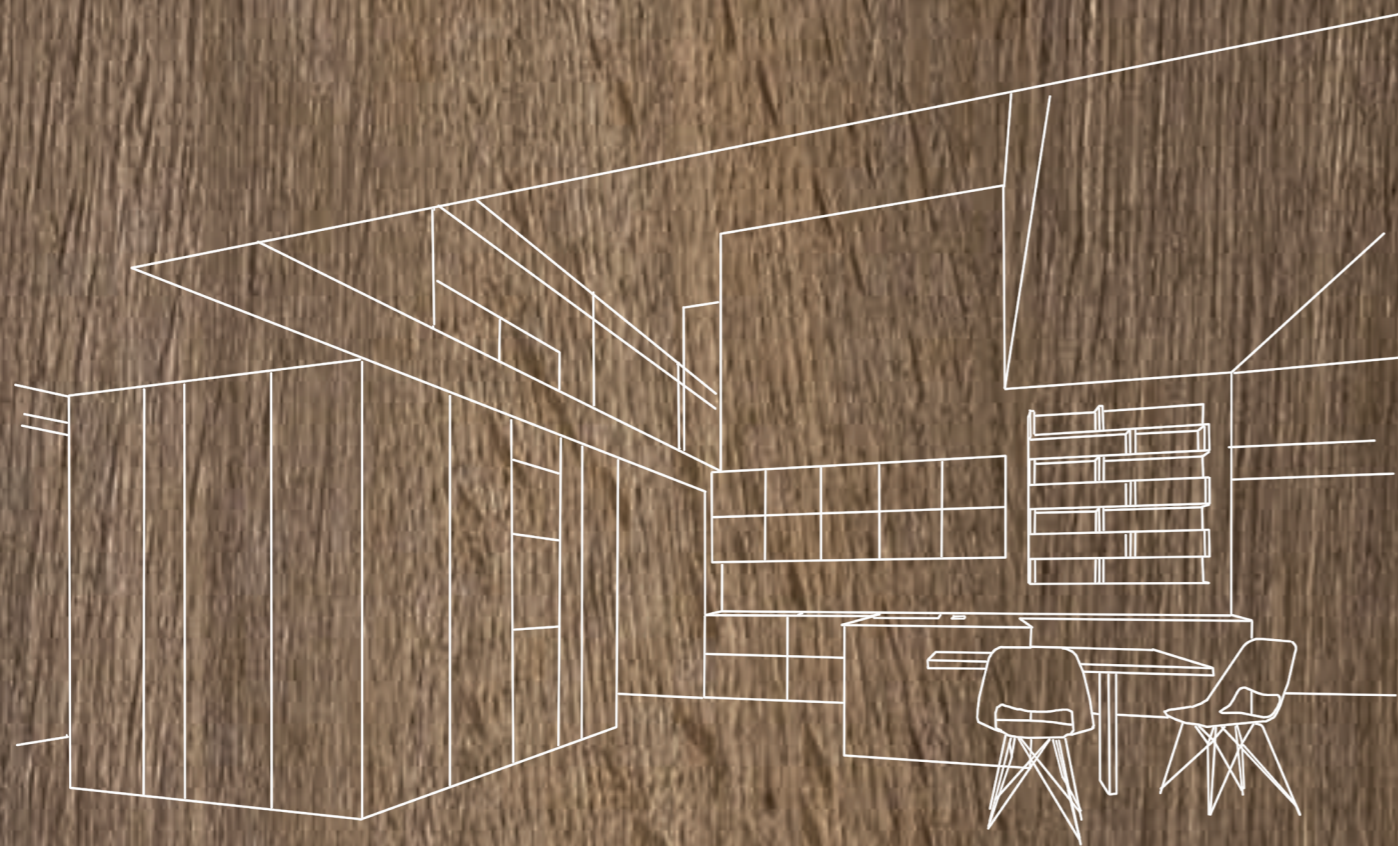

Tabacco nodato e spaccato H1181
Champagne
Rovere storico con bordo scortecciato
Dekton korus solid

kitchen 7 

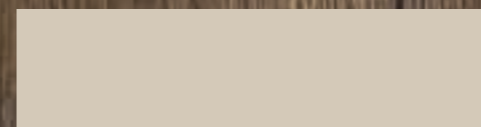



B22

Un accento giovanile e contemporaneo per questa variante di B22, basi cucina e penisola sono in nobilitato champagne, pensili e colonne in nobilitato rovere tabacco nodato e spaccato. Top in dektion finitura korus. La soluzione si sviluppa attorno ad un'isola snack in rovere antico con bordo scortecciato.

This B22 version gives a young and contemporary accent. Melamine champagne finished base units, melamine tobacco oak with nodes wall and tall units in. Dekton Korus finished countertop. The solution is built around an island, with an antique oak with debarked edge snack table.

Cette variante de B22 donne un accent jeune et contemporaine. Eléments bas et îlot en mélamine champagne, éléments haute et armoires en chêne tabac avec noeuds. Plan de travail en Dekton dans la finition Korus. La solution se développe tout autour du plan snack de l'îlot en chêne antique avec chants fendus.

Un acento joven y contemporáneo para esta variante de B22, con muebles bajos en melamina champagne, colgantes y columnas en melamina roble tabaco con nudos. Encimera en Dekton acabado korus. La solución se desarrolla alrededor de una isla snack en roble antiguo con el borde descortezado.





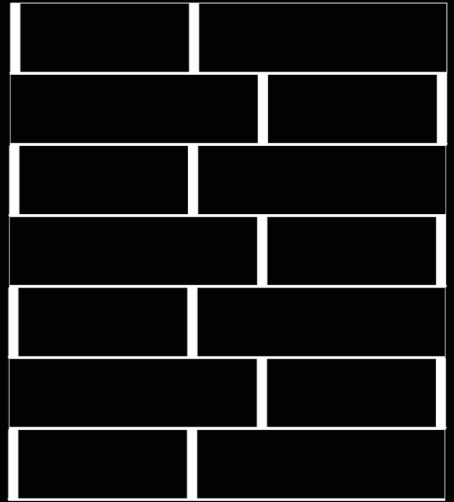

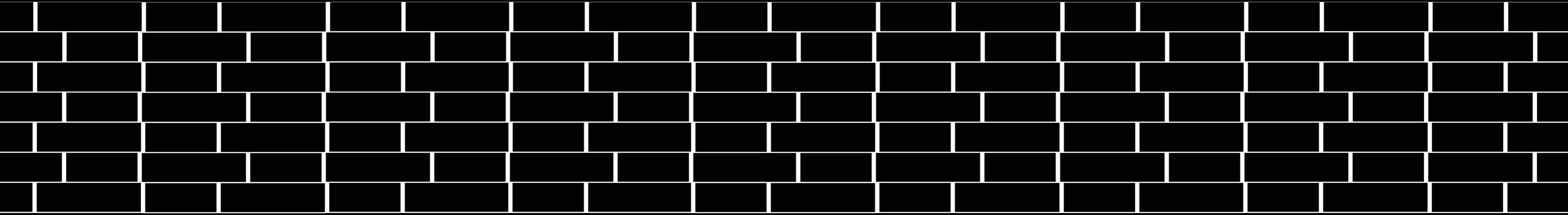

kitchen 7 

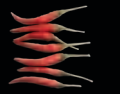

B22

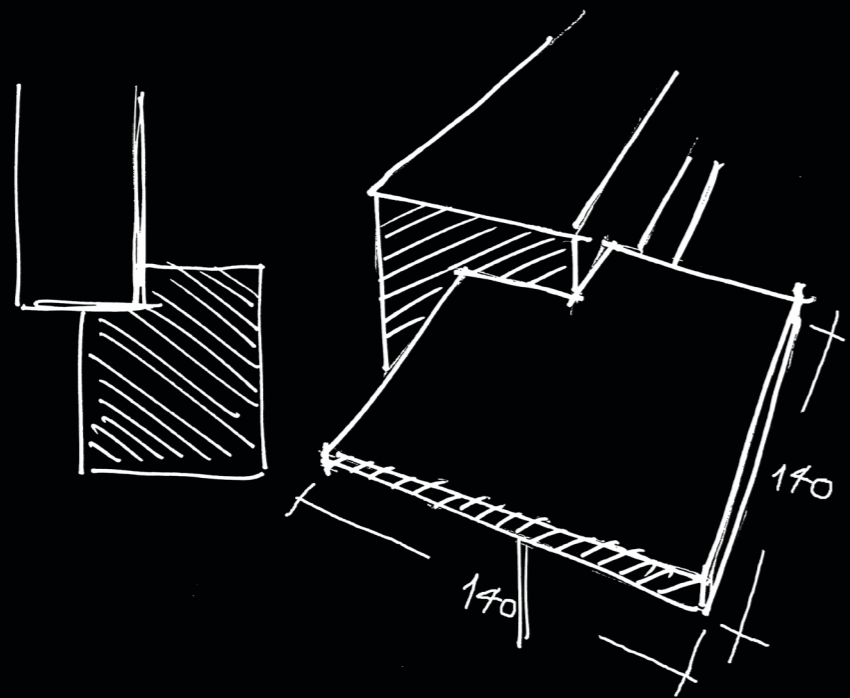
kitchen 7 



kitchen 7 



Perfette per un progetto di cucina-living, dove linee semplici e materiali pregiati garantiscono performance adeguate. Geometrie sempre in movimento, design ricercato, cercano forme compositive eleganti dal sapore contemporaneo per dare emozioni ai gesti quotidiani.

Perfect for a kitchen-living room project, where simple lines and rich materials ensure adequate performance. Moving geometries and elaborate design for elegant shapes, with a contemporary aspect, to give emotions to our daily life.

Parfaite pour un projet de cuisine-salon, où les lignes simples et les matériaux de qualité assurent des performances adéquates. Géométries toujours en mouvement et un dessin recherché, en recherchant des formes de composition élégantes avec un saveur contemporaine pour donner émotions aux gestes quotidiennes.

Perfectas para un proyecto de cocina-living, donde las líneas simples y los materiales de calidad aseguran un rendimiento adecuado. Geometrias siempre en movimiento y un diseño refinado para buscar formas compositivas elegantes con un sabor contemporáneo, para dar emociones a la vida diaria.



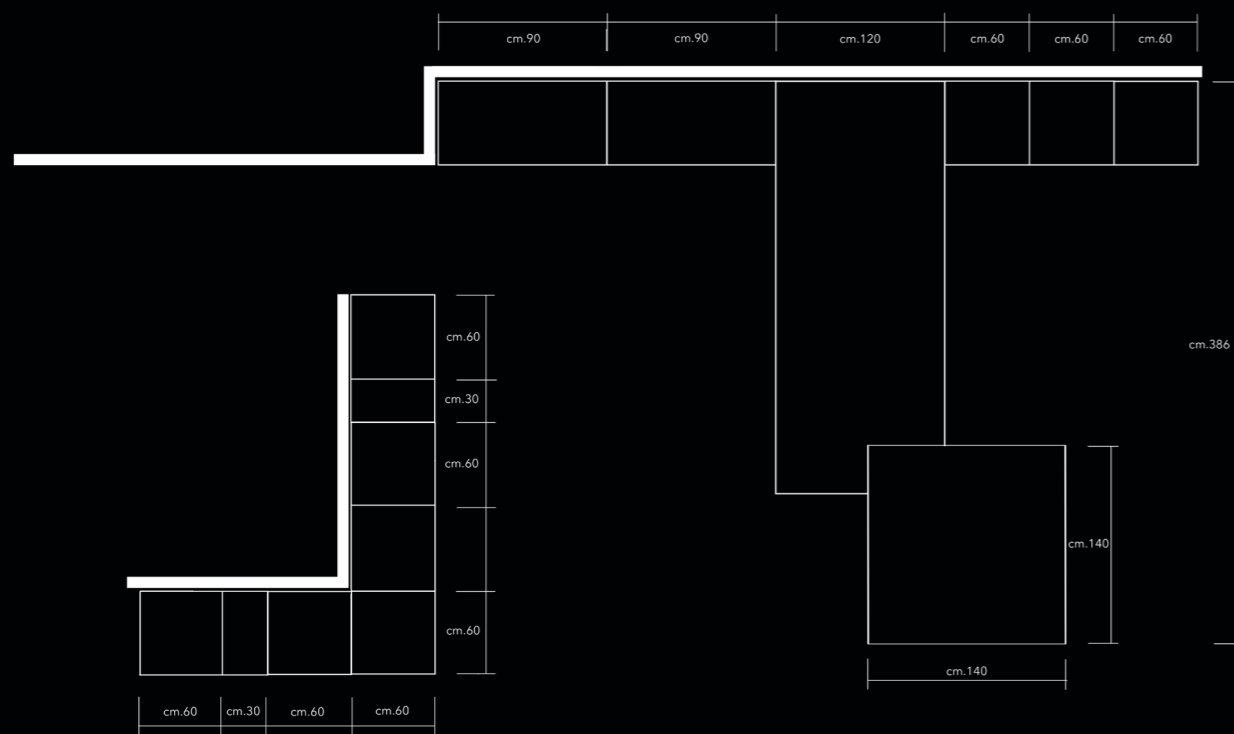

kitchen 7

Accessibile, personalizzabile, intelligente. B22 un progetto completo e unico che ti permette di arredare la tua cucina come preferisci. Composizioni a isola, pareti lineari, spazi ampi o ridotti, per avere sempre la soluzione che cerchi.

Affordable, customizable, intelligent. B22 is a complete and unique project that allows you to furnish your kitchen as you want. Compositions with island, linear walls, large or small spaces, to always have the solutions you are looking for.

Prix abordable, personnalisable, intelligent. B22, un projet complet et unique que vous permet de meubler votre cuisine selon vos besoins. Compositions avec îlot, murs linéaires, espaces ouverts ou réduits, pour avoir toujours la solution que vous recherchez.

Asequible, personalizable, inteligente. B22 es un proyecto completo y único que le permite de decorar su cocina a su gusto. Composiciones con isla, paredes lineales, espacios amplios o reducidos, para tener siempre la solución que buscava.



B22

MATERIALS

NOBILITATO

MELAMINE / MELAMINE / MELAMINA

VANGUARD NOCE P25

VANGUARD WALNUT P25 /
NOYER VALNUT P25 /
NOGAL VANGUARD P25



EUCALIPTO GRIGIO LR25

EUCALIPTO GREY LR25 /
EUCALIPTO GRIS LR25 /
EUCALIPTO GRIS LR25

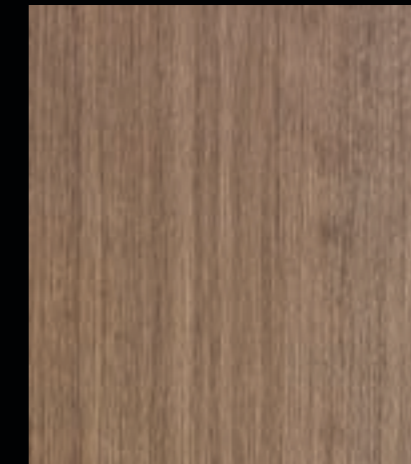

ROVERE NATURALE NODATO H1180

NATURAL OAK WHIT NODES H1180 /
CHENE NATUREL AVEC NOEUDS H1180 /
ROBLE NATURAL CON NUDOS H1180



EUCALIPTO NOCE CHAIRO LR27

EUCALIPTO LIGHT WALNUT LR27 /
EUCALIPTO NOYER CLAIR LR27 /
EUCALIPTO NOGAL CHAIRO LR27

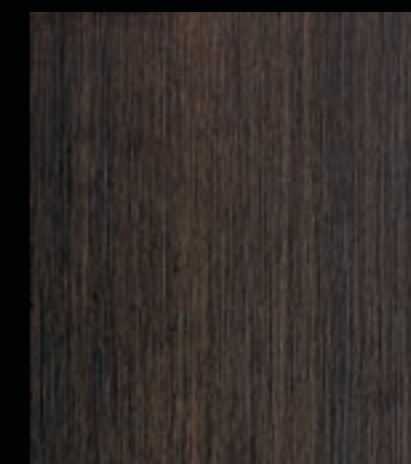

ROVERE TABACCO NODATO H1181

TABACCO OAK WHIT NODES H1181 /
ROBLE TABAC AVEC NOEUDS H1181 /
ROBLE TABACO CON NUDOS H1181

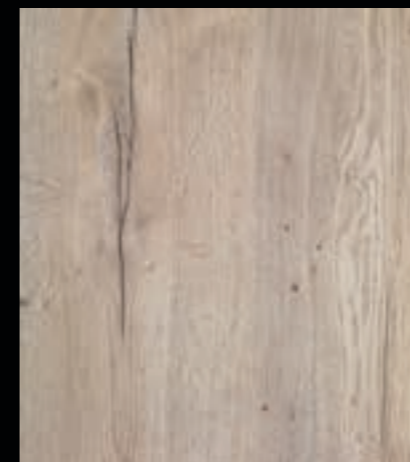

EUCALIPTO NOCE SCURO LR29

EUCALIPTO DARK WALNUT LR29 /
EUCALIPTO NOYER FONCÉ LR29 /
EUCALIPTO NOGAL OSCURO LR29

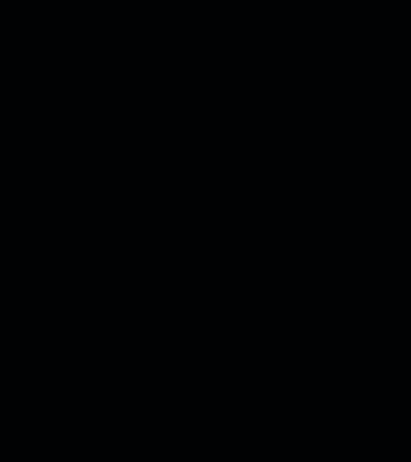

ROVERE BIANCO NODATO H1176

WHITE OAK WHIT NODES H1176 /
ROBLE BLANC AVEC NOEUDS H1176 /
ROBLE BLANCO CON NUDOS H1176



CEMENTO GRIGIO FB02
 GREY CEMENT FB02 /
 CIMENT GRIS FB02 /
 CEMENTO GRIS FB02



CHAMPAGNE
 CHAMPAGNE /
 CHAMPAGNE /
 CHAMPAGNE



CEMENTO PERLATO FB53
 PEARL CEMENT FB53 /
 CIMENT PERLÈ FB53 /
 CEMENTO PERLADO FB53



GRIGIO COBALTO
 COBALTO GREY /
 GRIS COBALTO /
 GRIS COBALTO



CEMENTO BIANCO FB50
 WHITE CEMENT FB50 /
 CIMENT BLANC FB50 /
 CEMENTO BLANCO FB50



BIANCO LK0
 WHITE LK0 /
 BLANC LK0 /
 BLANCO LK0

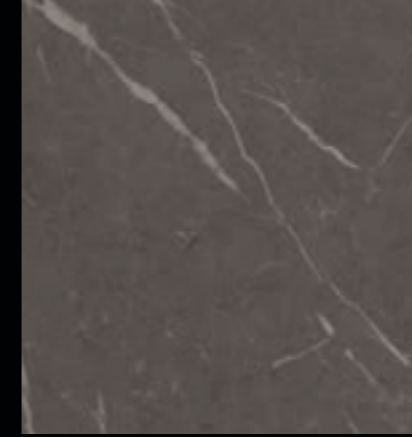

MARMO TABACCO 6014SK
 TOBACCO MARBLE 6014SK /
 MARBRE TABAC 6014SK /
 MÁRMOL TABACO 6014SK

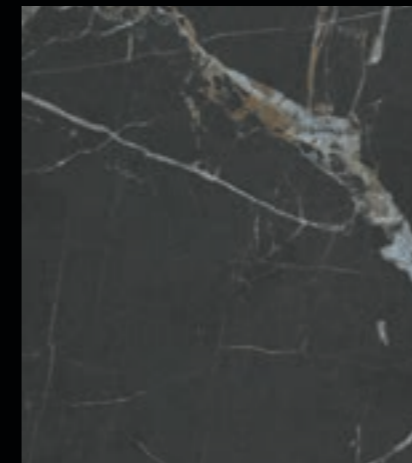

MARMO NERO 6133SK
 BLACK MARBLE 6133 SK /
 MARBRE NOIR 6133 SK /
 MÁRMOL NEGRO 6133 SK



STATUARIO BIANCO 6019SK
 WHITE MARBLE 6019SK /
 MARBRE BLANC 6019SK /
 MÁRMOL BLANCO 6019SK

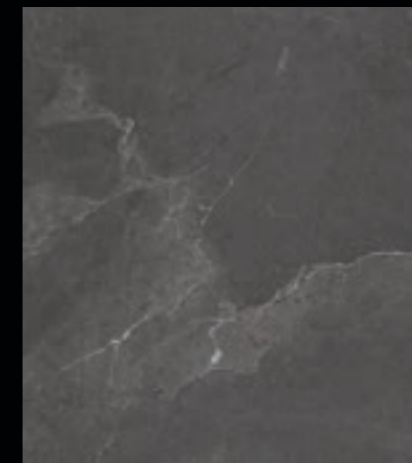

GRIGIO TALCO TD3
 GRAY TALC TD3 /
 TALC GRIS TD3 /
 TALCO GRIS TD3



BIANCO KOS
KOS WHITE /
BLANC KOS /
BLANCO KOS



GRIGIO EFESO
EFESO GREY /
GRIS EFESO /
GRIS EFESO



GRIGIO LONDRA
LONDON GREY /
GRIS LONDRA /
GRIS LONDRA

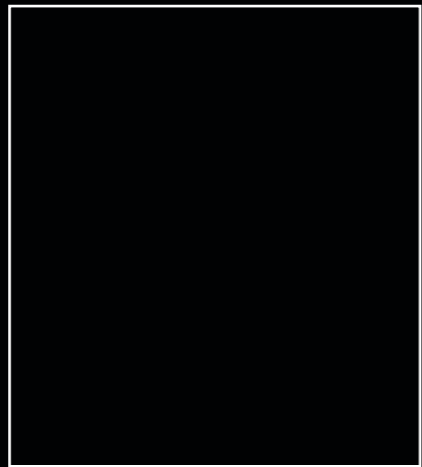

NERO
BLACK /
NOIR /
NEGRO



CASTORO OTTAWA
OTTAWA BEAVER /
CASTOR OTTAWA /
CASTOR OTTAWA



GRIGIO BROMO
BROMO GREY /
GRIS BROMO /
GRIS BROMO



BIANCO OPACO
MATT WHITE /
BLANC MAT /
BLANCO MATE



BIANCO LUCIDO
GLOSS WHITE /
BLANC BRILLANT /
BLANCO BRILLO



GRIGIO OPACO
MATT GREY /
GRIS MAT /
GRIS MATE



GRIGIO LUCIDO
GLOSS GREY /
GRIS BRILLANT /
GRIS BRILLO



RAL-NCS OPACO
MATT RAL-NCS /
RAL-NCS MAT /
RAL-NCS MATE



RAL-NCS LUCIDO
GLOSS RAL-NCS /
RAL-NCS BRILLANT /
RAL-NCS BRILLO



MANIGLIE PER GOLA

HANDLES FOR CHANNEL PROFILE · POIGNÉE POUR GORGE · TIRADORES PARA RANURA

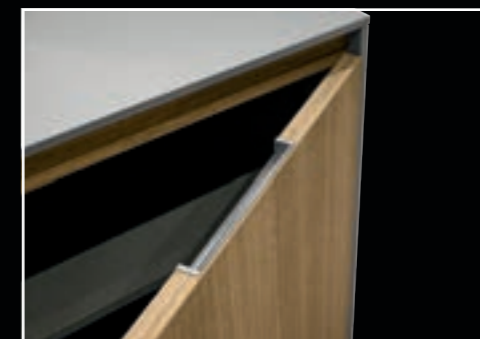
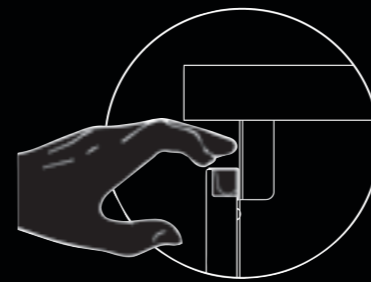

MANIGLIA INCASSATA FINITURA ACCIAIO SATINATO COD.177SAG
SATIN STEEL FINISH RECESSED HANDLE COD.177SAG /
SATIN STEEL FINISH RECESSED HANDLE COD.177SAG /
TIRADOR ENCAJADA ACABADO ACERO SATINADO COD.177SAG

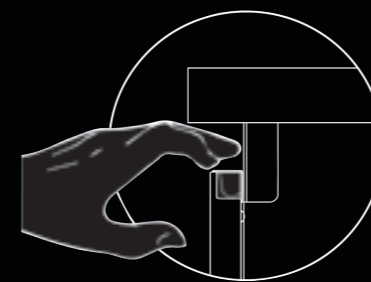

MANIGLIA INCASSATA FINITURA BRUNITA COD.177 BRG
BURNISH FINISH RECESSED HANDLE COD.177BRG /
POIGNÉE ENCASTRÉE FINITION BRUNIE COD.177BRG /
TIRADOR ENCAJADO ACABADO BRUÑIDO COD.177BRG



MANIGLIA CONCAVA BORDO ANTA FINITURA ACCIAIO SATINATO COD. 174
SATIN STEEL FINISH CONCAVE HANDLE COD.174 /
POIGNÉE CONCAVE ENCASTRÉE EN FINITION ACIER SATINÉ COD.174 /
TIRADOR CONCAVO ACABADO ACERO SATINADO COD.174

MANIGLIE MODULARI
 MODULAR HANDLES / POIGNÉES MODULAIRES
 TIRADORES MODULARE

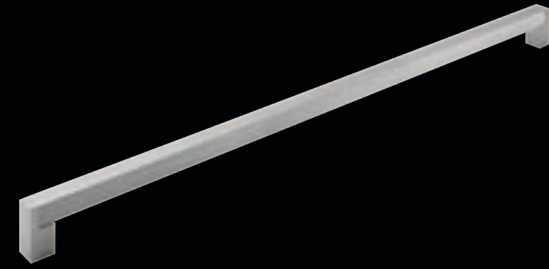

CODICE 170
 CODE 170 / **CODE 170** / CÓDIGO 170



CODICE 156
 CODE 156 / **CODE 156** / CÓDIGO 156



CODICE 162
 CODE 162 / **CODE 162** / CÓDIGO 162



CODICE 164
 CODE 164 / **CODE 164** / CÓDIGO 164

MANIGLIE
 HANDLES POIGNÉES TIRADORES

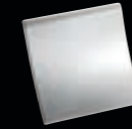

CODICE 135
 CODE 135 / **CODE 135** / CÓDIGO 135



CODICE 141
 CODE 141 / **CODE 141** / CÓDIGO 141



CODICE 151
 CODE 151 / **CODE 151** / CÓDIGO 151



CODICE 142
 CODE 142 / **CODE 142** / CÓDIGO 142



CODICE 152
 CODE 152 / **CODE 152** / CÓDIGO 152



CODICE 143
 CODE 143 / **CODE 143** / CÓDIGO 143



CODICE 153
 CODE 153 / **CODE 153** / CÓDIGO 153



CODICE 140
 CODE 140 / **CODE 140** / CÓDIGO 140



CODICE 145
 CODE 145 / **CODE 145** / CÓDIGO 145



Tutti i diritti sono riservati, è vietata la riproduzione, anche parziale, delle immagini.
All rights are reserved, the reproduction of the images, even partial, is prohibited.
Tous droits sont réservés, la reproduction des images, même si partielle, est interdite.
Todos los derechos son reservados, la reproducción, también parcial, de las imagenes es prohibida.

PROGETTO
C.R.S. TRE O

ART BUYER
LAURA COMIOTTO

IMMAGINI E GRAFICA
IKB FOTO
CARLO GESSAGA
BRUNO VEZZOLI

STAMPA
GRAFICHE ANTIGA

